

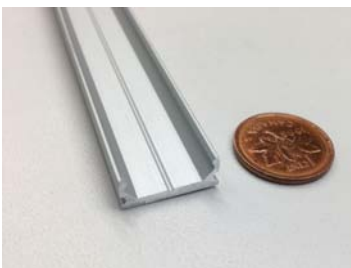

PROFILE KATANA

The Katana is a simple extrusion with a low profile, giving you option for creating lighting effects in very unique locations without giving up functionality.



Size reference

Profile

Extruded aluminium construction
Anodized finish
Available in custom length
 $L \leq [8']$ (2,44 m)
Easy wiring: profiles sections connect directly to each other via connectors (or using a connectors equipped jumper wire if necessary)
Caps included
Outdoor IP rating available,
call for details

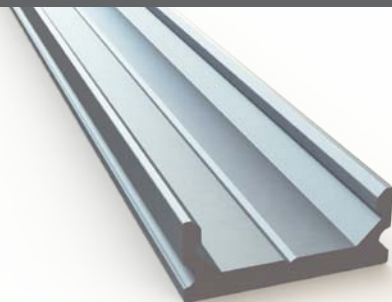

HOW TO ORDER KATANA?

Please pick your profile:

Add a length: (m)

e.g. 555-815-2.00

part no. **555** - **815** - -

LENGTH

555 profile **815** Katana

Please pick your lens:

Add a length: (m)

e.g. 555-502-2.00

part no. **555** - -

LENGTH

MODEL LENS

555 profile **500** frosted
 502 clear
 509 high
 frosted

Please pick your LED:

Add a length: (m) *check cut length

part no. **551** - - - - -

e.g. 551-580-030-40-2.00

CRI	LED	STYLE	COLOUR TEMPERATURE	LENGTH
580 <85	ECO	030 360	95 2300 K (proLP only)	
		060 680	90 2700 K	
		095 1080	70 3000 K	
		065 650	40 4000 K	
		085 850	55 5500K	
780 >85	PRO-LP	105 1050	98 RGB	
		100 1080		
		RGB		
		RGB+W		

Your final number is:

e.g. 555-815-502-551-580-030-40-2.00

part no. **555** - **815** - - **551** - - - - -

MODEL PROFILE STYLE LENS CRI STYLE COLOUR TEMPERATURE OVERALL LENGTH

For your reference:

LED Pixelation

in profile with frosted lens

Katana flat

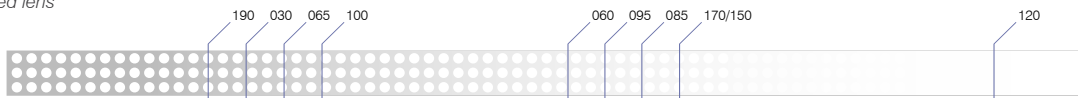

Katana round

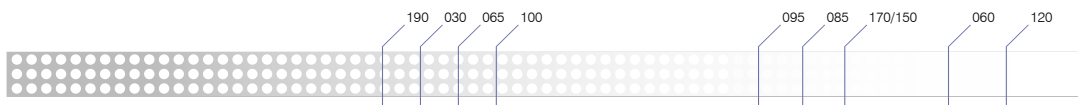

24V LINEAR LED LIGHT SOURCE

MILES ECO

STYLE	LED/M	WATT/M	LUMENS	CRI	MAX. LENGTH	CUT LENGTH	COLOUR TEMPERATURE				
							2300	2700	3000	4000	5500
030	60	4.8	360	83	5.0m	100mm		●	●	●	●
060	120	9.6	680	83	5.0m	50mm		●	●	●	●
095	60	14.4	1080	83	5.0m	100mm		●	●	●	●

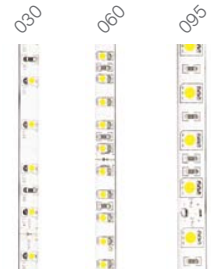

MILES PRO-LP

STYLE	LED/M	WATT/M	LUMENS	CRI	MAX. LENGTH	CUT LENGTH	COLOUR TEMPERATURE				
							2300	2700	3000	4000	5500
065	71	6	650	83	8.5m	84mm	●	●	●	●	●
085	100	8.3	850	83	7.5m	60mm	●	●	●	●	●
105	200	9.5	1050	83	6.0m	30mm	●	●	●	●	●

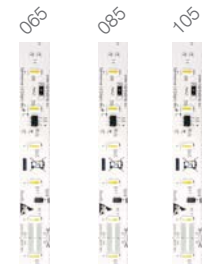

MILES PRO-HP

STYLE	LED/M	WATT/M	LUMENS	CRI	MAX. LENGTH	CUT LENGTH	COLOUR TEMPERATURE				
							2300	2700	3000	4000	5500
100	40	10.6	1080	85	6.0m	150mm		●	●	●	●



MILES RGB

STYLE	LED/M	WATT/M	LUMENS	CRI	MAX. LENGTH	CUT LENGTH
RGB	60	14.4	670		5.0m	100mm



RGB

MILES RGB+W

STYLE	LED/M	WATT/M	LUMENS	CRI	MAX. LENGTH	CUT LENGTH
RGB+W	266	22.25	1193		3.25m	90mm



RGB+W

Accessories for Katana:

End caps (provided)

Cap With Connector Hole
part number **555-815-01**

- Allows the installation of connectors
- Aluminium construction
- Used on both ends with male/female combination of connectors for pass through profile sections

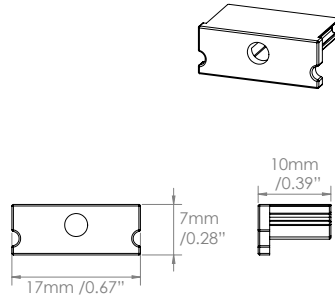

Terminal Cap
part number **555-815-00**

- Used to end a section of profile
- Aluminium construction
- Installed on one end of profile section with the other end terminated by a cap with a connector.

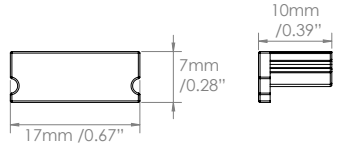

Lens

PMMA construction
Easily clipped in profile
Comes precut to match profile length

part number **555-500 (frosted)**
555-502 (clear)
555-509 (frosted high lens)

flush
clear 95% transparent
frosted 65% transparent

high
frosted 65% transparent

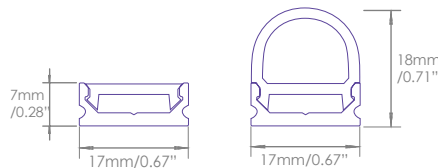

Round Cap With Connector Hole
part number **555-815-11**

- Allows the installation of connectors
- Aluminium construction
- Used on both ends with male/female combination of connectors for pass through profile sections

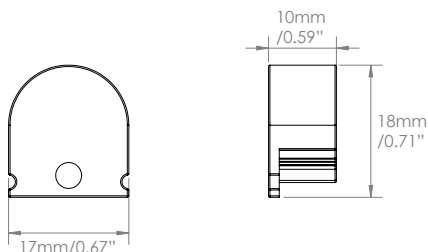

Terminal Round Cap

part number **555-815-10**

- Used to end a section of profile
- Aluminium construction
- Installed on one end of profile section with the other end terminated by a cap with a connector.

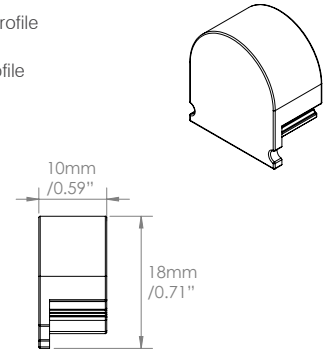
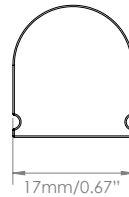

Mounting Clip

part number **555-815-20**

- Steel construction
- Profile is mounted flush to surface
- Not visible once installed

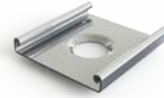

45° Mount Clip

part number **555-815-21**

- Steel construction
- Profile is mounted flush to surface
- Not visible once installed



Jumper Wire

part number **555-101-8 (8")**
555-101-16 (16")
555-101-32 (32")
555-101-XX (custom)

- Allows connections between sections of profiles that cannot be linked directly
- Comes with set of connectors pre-installed



Lead Cable for Driver

part number **555-100-36 (36")**
555-100-XX (custom)

- Comes preinstalled to the driver box
- Connector preinstalled: ready to plug to profiles

